

Pressure Calibration Kit

2011-2016 GM Allison 1000 Series 800HP+
(128041012)

Installation Guide



DISCLAIMER OF LIABILITY

Performance products can increase horsepower above and beyond factory specifications. Additional horsepower creates more stress on the drive-train components, which could result in drive-train failure.

Note regarding emissions-related, non-E.O.-legal products: THESE PRODUCTS ARE LEGAL IN CALIFORNIA ONLY FOR RACING VEHICLES THAT MAY NEVER BE USED, OR REGISTERED OR LICENSED FOR HIGHWAY OR OFF-ROAD USE.

This agreement sets forth the terms and conditions for the use of PPE products. The installation of this product indicates that the Buyer has read and understands this agreement and accepts the terms and conditions. PPE (Pacific Performance Engineering) Inc., its distributors, employees, and dealers (the "Seller") shall not be responsible for the product's proper use and service. The buyer hereby waives all liability claims. The Buyer hereby acknowledges no reliance on the Seller's skill or judgment to select or furnish goods suitable for any particular purpose and that there are no liabilities which extend beyond the description on the face hereof, and the Buyer hereby waives all remedies or liabilities expressed or implied, arising by law or otherwise (including without any obligation of the Seller with respect to fitness, merchantability and consequential damages), or whether or not occasioned by the Seller's negligence. The Seller disclaims any warranty and expressly disclaims any liability for personal injury or damages. The Buyer acknowledges and agrees that the disclaimer of any liability for personal injury is a material term for this agreement and the Buyer agrees to indemnify the Seller and to hold the Seller harmless from any claim related to the item of equipment purchased. Under no circumstances will the Seller be liable for any damages or expenses by reason of use or sale of any such equipment. The Seller assumes no liability regarding the improper installation or misapplication of its products. It is the installer's responsibility to check for proper installation and if in doubt, contact the manufacturer. The Buyer is solely responsible for all warranty issues from the manufacturer.

LIMITATION OF WARRANTY

The Seller gives Limited Warranty as to description, quality, merchantability, and fitness for a particular purpose, productiveness, or any other matter of Seller's product sold herewith. The Seller shall not be responsible for the products proper use and service and the Buyer hereby waives all rights other than those expressly written herein. This warranty shall not be extended, altered or varied except by a written instrument signed by Seller and Buyer. The Warranty on PPE Manifolds and Up-Pipes Kits, OEM-Length Up-Pipes is three (3) years, a limited lifetime warranty on PPE cast aluminum pans and covers, and a limited lifetime warranty on PPE Transmission Coolers and one (1) year limited warranty on all other PPE products from the date of sale to original buyer and limited solely to the parts contained within the products kit. All products that are in question of Warranty must be returned prepaid to the Seller and must be accompanied by a dated proof of purchase receipt. All Warranty claims are subject to approval by Seller. Under no circumstances will the Seller be liable for any labor charged or travel time incurred in diagnosis for defects, removal, or re-installation - of this product or any other contingent expenses. Under no circumstances will the Seller be liable for any damage or expenses incurred by reason of the use or sale of any such equipment. In the event that the buyer does not agree with this agreement: the buyer may promptly return this product, in a new and unused condition in its original packaging, with a dated proof of purchase to the place of purchase within ten (10) days from date of purchase for a full refund. The installation of this product indicates that the buyer has read and understands this agreement and accepts its terms and conditions.

Contents:

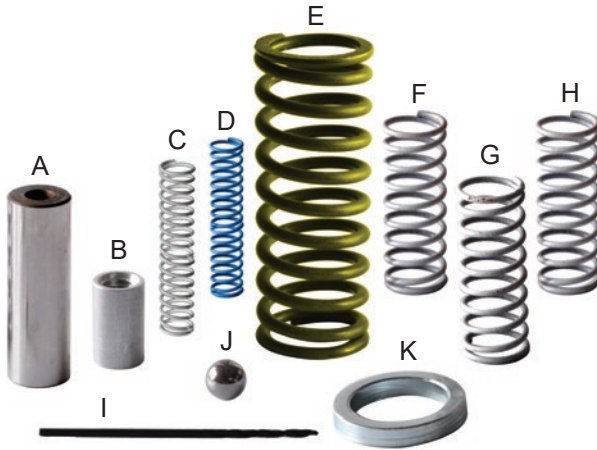

- A EPC Regulator Valve
- B Line Plug
- C Tan Spring (over 1000HP)
- D Blue Spring (under 1000HP)
- E Yellow Pressure Regulator Valve Spring
- F, G, H Shift Valve Springs
- I .047" Drill Bit
- J Steel Ball
- K Shim

Installation:

A sticking E Shift Valve can cause Code P1711 or P0872 to be displayed.

STEP 1

Shift Valve Body

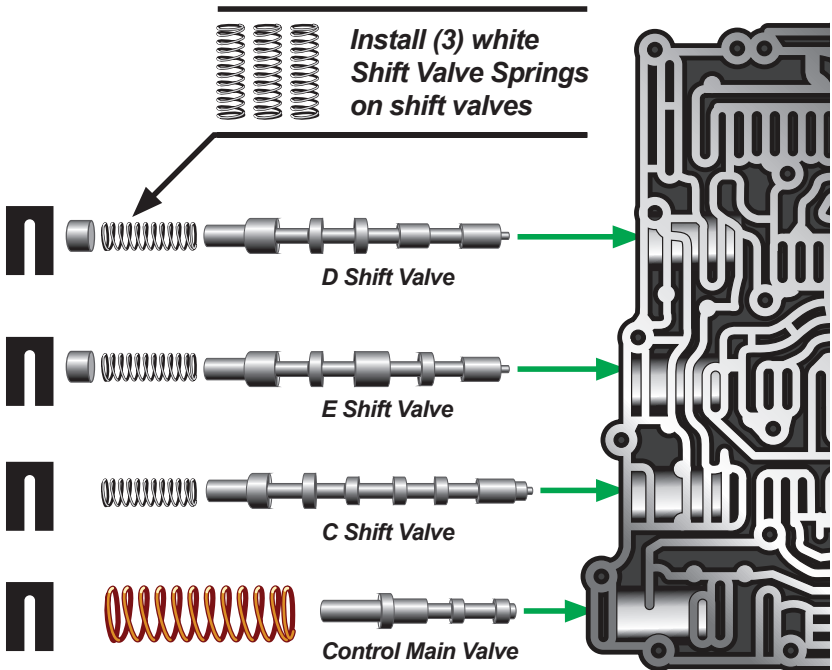

Install the three PPE white springs on to the D, E and C Shift Valves.

Bore cleaning:

Hacksaw slot in brake line tubing. Then insert a strip of 180 grit wet or dry sandpaper. Spin (by hand) inside the bore to remove high spots.

Check by freezing Shift Valve Body for one half-hour. If valves remain free the installation will perform properly in the truck.

STEP 2

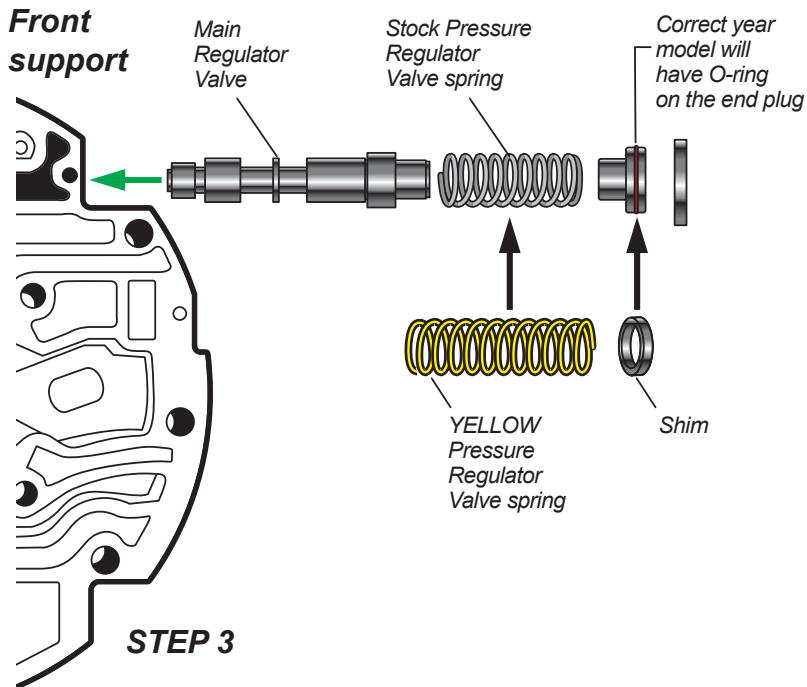

STEP 3

Install new YELLOW Pressure Regulator Valve spring.

Install silver shim if horsepower will exceed 800HP.

Spacer plate

STEP 4

Drill indicated hole with .047" drill furnished.

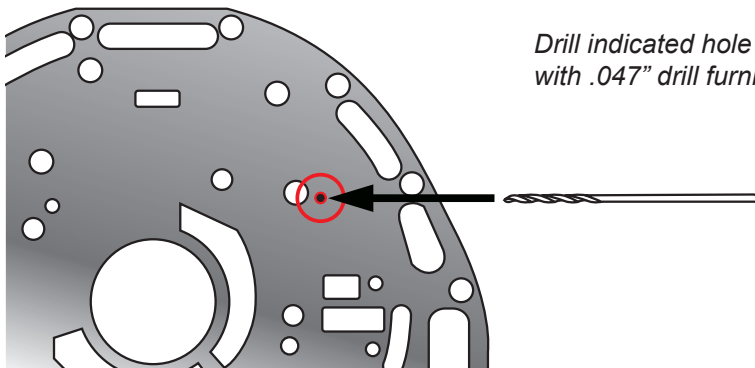

STEP 5

Main Valve Body | 2011 and later style

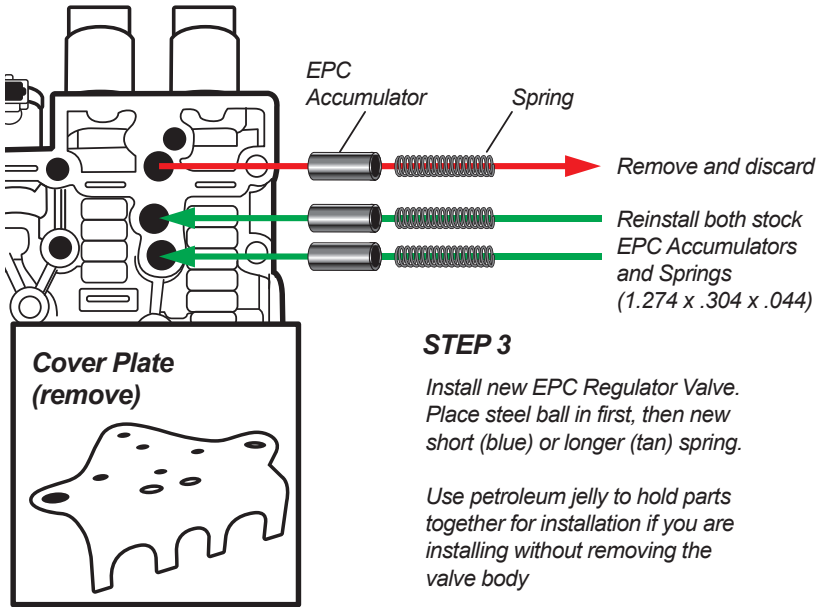

*** EPC Regulator Valve Assembly**

For street trucks under 1000HP, use **BLUE Spring**.
 For trailered race trucks over 1000HP, use longer **TAN Spring**.

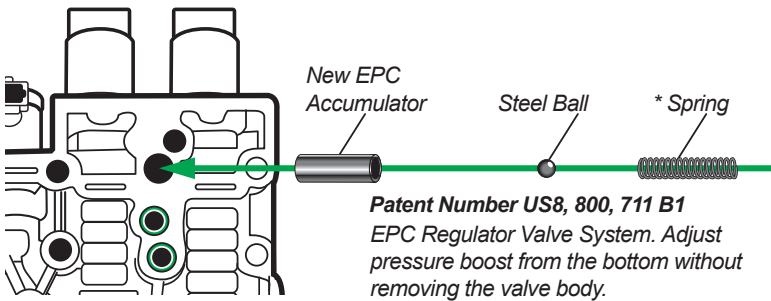

Pop-Off Valve

2011 and later models use a Pop-Off Valve. These are not serviceable and prone to leak due to metal contamination.

Always install the Line Plug into the stator support (as shown below).

The new EPC Regulator Valve in this kit provides the safety for over-pressurization without the risk of low-pressure that can happen with the factory Pop-Off Valve.

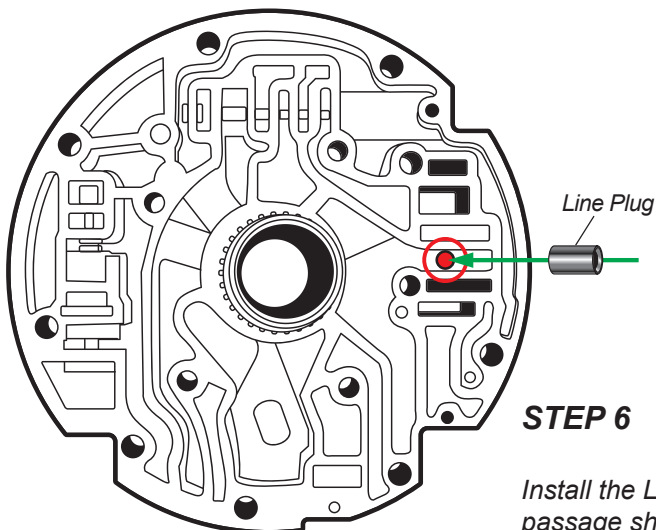
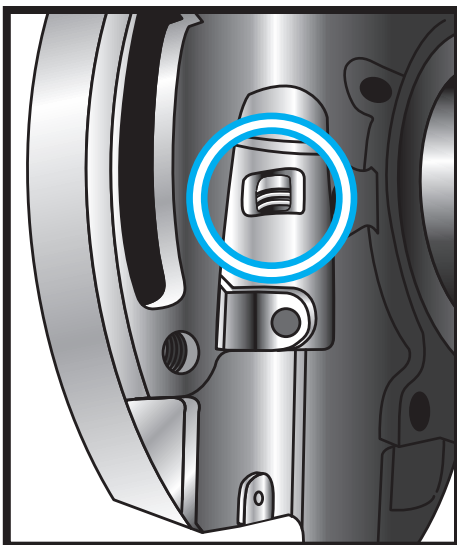

Install the Line Plug into the passage shown in the diagram.

Stake with a chisel at the top of the bore to keep the Line Plug from moving out of position.



PPEpower.com
sales@PPEpower.com
Phone: (714) 985-4825